

# Bus module BCM 500 for FCU 5xx, BCU 5xx or FDU 5xx

## OPERATING INSTRUCTIONS

· Edition 12.22 · EN · 03251353



### CONTENTS

1 Safety . . . . .	1
2 Checking the usage . . . . .	2
3 Installation . . . . .	3
4 Wiring . . . . .	3
5 Commissioning . . . . .	4
6 Assistance in the event of malfunction . . . . .	6
7 Technical data . . . . .	8
8 Logistics . . . . .	8
9 Disposal . . . . .	8

## 1 SAFETY

### 1.1 Please read and keep in a safe place



Please read through these instructions carefully before installing or operating. Following the installation, pass the instructions on to the operator. This unit must be installed and commissioned in accordance with the regulations and standards in force. These instructions can also be found at [www.docuthek.com](http://www.docuthek.com).

### 1.2 Explanation of symbols

**1, 2, 3, a, b, c** = Action

→ = Instruction

### 1.3 Liability

We will not be held liable for damage resulting from non-observance of the instructions and non-compliant use.

### 1.4 Safety instructions

Information that is relevant for safety is indicated in the instructions as follows:

#### **⚠ DANGER**

Indicates potentially fatal situations.

#### **⚠ WARNING**

Indicates possible danger to life and limb.

#### **⚠ CAUTION**

Indicates possible material damage.

All interventions may only be carried out by qualified gas technicians. Electrical interventions may only be carried out by qualified electricians.

### 1.5 Conversion, spare parts

All technical changes are prohibited. Only use OEM spare parts.

## 2 CHECKING THE USAGE

The bus module BCM 500 is used as a communication interface for protective system controls FCU 5xx (from construction stage B), burner control units BCU 5xx or flame detectors FDU 5xx for connecting to a fieldbus interface.

Networking via the fieldbus enables FCU 5xx and BCU 5xx units to be controlled and monitored by an automation system (e.g. PLC).

This function is only guaranteed when used within the specified limits – see page 8 (7 Technical data). Any other use is considered as non-compliant.

### 2.1 Type code

<b>BCM</b>	Bus module
<b>500</b>	Series 500
<b>S0</b>	Standard communication
<b>B2</b>	PROFINET
<b>B4</b>	Modbus TCP
<b>/3</b>	Two RJ45 sockets
<b>-3</b>	Three-point step control via bus

### 2.2 Part designations

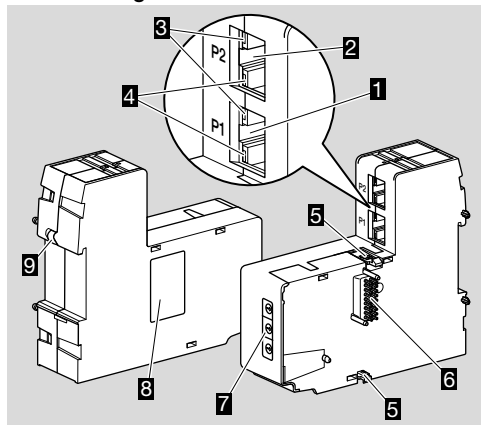

- 1 RJ45 socket (port P1) for connecting to the bus communications system
- 2 RJ45 socket (port P2) for connecting to the bus communications system
- 3 Yellow LED  
(to indicate the transfer rate: on = 100 Mbit, off = 10 Mbit)
- 4 Green LED  
(to indicate a connection: off = no connection, on = connection, flashing = data transfer)
- 5 Detents
- 6 Contact strip (18 pins)
- 7 Code switches
- 8 Type label
- 9 PE contact

### 2.3 Type label

MAC address and ambient temperature – see type label.

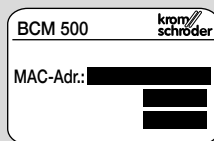

### 3 INSTALLATION

- Installation position: vertically upright, horizontal or tilted to the left or right.
- The BCM mounting is designed for horizontally aligned 35 × 7.5 mm DIN rails.

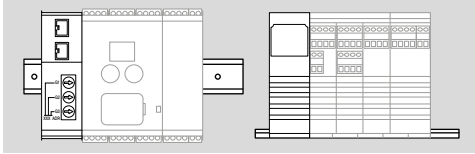

- If the DIN rail is aligned vertically, end clamps are required (e.g. Clipfix 35 by Phoenix Contact) to prevent the control unit from slipping.

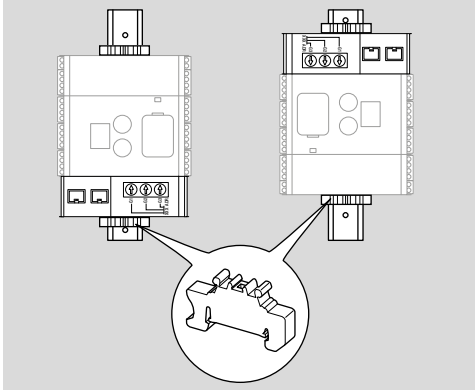

- Install in a clean environment (e.g. a control cabinet) with an enclosure  $\geq$  IP 54, whereby no condensation is permitted.

- 1 Disconnect the system from the electrical power supply.

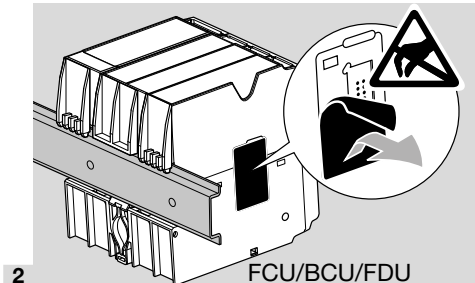

2

#### ⚠ CAUTION

Do not touch the BCM's contact strip and the FCU/BCU/FDU's contact socket during installation. The devices' electronic systems can be damaged by electrostatic discharge (ESD).

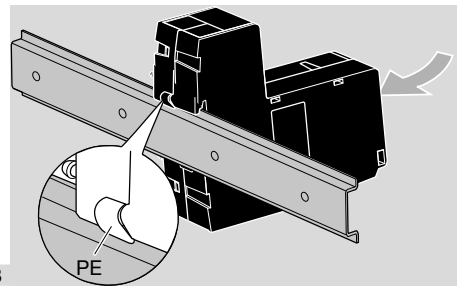

3

- Ensure there is a good PE (ground) wire connection between the DIN rail and the BCM's PE contact.

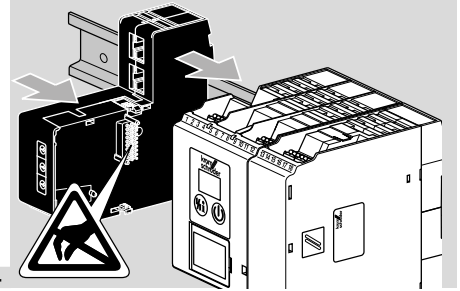

4

#### ⚠ CAUTION

Do not jam the BCM as you slide it on to the control unit (FCU, BCU or FDU). Otherwise, the contact strip (18 pins) may be damaged. The two detents on the BCM must engage correctly in the corresponding recesses in the control unit to ensure it is correctly secured.

### 4 WIRING

- 1 Disconnect the system from the electrical power supply.
  - Use only cable and plug components which comply with the appropriate fieldbus specifications.
  - Use shielded RJ45 plugs.
  - Cable length: max. 100 m between 2 subscribers.
  - PROFINET installation guidelines, see [www.profinet.com](http://www.profinet.com).
  - Modbus specifications, see [www.modbus.org](http://www.modbus.org).
- 2 Connect the BCM 500 to the fieldbus on an automation system.

## 5 COMMISSIONING

Depending on the bus module version (BCM..B2 or BCM..B4), fieldbus communication can be configured using the engineering tool of the automation system or using BCSofT.

→ The BCSofT operating instructions and software can be downloaded from [www.docuthek.com](http://www.docuthek.com).

**1** Check the code switch settings (001 to FEF) on the BCM for communication between BCSofT and the control unit via Ethernet.

→ Each code switch setting combination may only exist once within the fieldbus system.

→ Each device name/network name and each IP address may only be allocated once within the fieldbus system.

→ A device within the fieldbus system can be identified using the subscriber flash test (BCU, FCU: display shows **00** with alternately highlighted segments).

→ For instructions on commissioning the control unit, see the operating instructions for BCU 56x, 580, BCU 570, FCU 500 or FDU 5x0.

### 5.1 BCM..B2 (PROFINET)

#### WARNING

Risk of explosion!

Do not enable the BCM and control unit (BCU/FCU/FDU) for operation until the parameter settings and wiring are correct and the faultless processing of all input and output signals has been ensured.

In the event that the bus communication is faulty or interrupted, or the communications data is invalid, or during initialization, the signals received from the PROFINET controller are interpreted as "0". If the control unit is controlled using the inputs at terminals 1 to 4, terminal 44 (menox) or terminal 50 (purge) during this, the normal program runs.

→ All the device-specific parameters for the control unit (BCU/FCU/FDU) are saved in the device master data file (GSD): download the device master data file (GSD) from [www.docuthek.com](http://www.docuthek.com).

→ Read the GSD file into the engineering tool of the automation system and complete the network configuration.

→ The steps required for this are described in the instructions for the engineering tool.

**1** Connect mains voltage to the control unit.

→ If the display on the control unit blinks and shows **n 3**, the bus communication has not been configured correctly.

**2** Configure the bus communication.

→ **Using the engineering tool of the automation system:** enter the device name for the control unit.

→ Using BCSofT: enter the network name, IP address, subnet mask and standard gateway for the control unit.

→ Only when the device name/network name has been entered, does the control unit receive unique identification in the PROFINET IO system.

→ On the control unit, parameter 80 must be set to 1 or 2 so that a device name/network name can be entered for the BCM, see page 5 (5.3 Parameter 80).

### 5.2 BCM..B4 (Modbus TCP)

#### WARNING

Risk of explosion!

Do not enable the BCM and control unit (BCU/FCU/FDU) for operation until the parameter settings and wiring are correct and the faultless processing of all input and output signals has been ensured.

In the event that the bus communication is faulty or interrupted, the control unit can continue to be activated via the inputs at terminals 1 to 4, terminal 44 (menox) or terminal 50 (purge). The normal program runs.

**1** Connect mains voltage to the control unit.

→ If the display on the control unit blinks and shows **n 3**, the bus communication has not been configured correctly.

**2** Configure the bus communication.

→ Enter the network name, IP address, subnet mask and standard gateway for the control unit.

→ On the control unit, parameter 80 must be set to 1 or 2 so that a network name can be entered for the BCM, see page 5 (5.3 Parameter 80).

### 5.3 Parameter 80

- Depending on the setting of parameter 80, bus communication may take place with or without an address check.
- Check the value of parameter 80 using BCSoft and adjust it if necessary.

Parameter	
No.	Name Possible values for bus communication
80	Fieldbus communication 0 = Off 1 = With address check 2 = No address check

- For further instructions on setting the parameters, see the operating instructions for BCU 56x, 580, BCU 570, FCU 500 or FDU 5x0, section entitled "Adjustment".

#### Parameter 80 = 0:

##### Fieldbus communication Off

- Fieldbus communication is switched off. Access to the unit via Ethernet is still possible using BCSoft.

#### Parameter 80 = 1:

##### Fieldbus communication with address check

- The device name/network name on delivery is: e.g. for FCU 500: "fcu-500-xxx" ("not-assigned-fcu-500-xxx" if configured using the engineering tool), e.g. for BCU 570: "bcu-570-xxx" ("not-assigned-bcu-570-xxx" if configured using the engineering tool). The sequence xxx stands for the address set on the code switches of the BCM 500 (xxx = address in the range 001 to FEF).

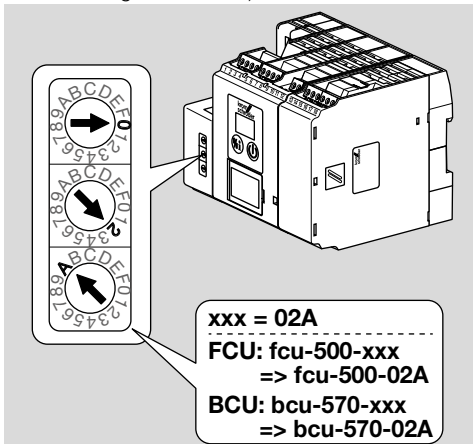

- The expression "not-assigned-" must be deleted.
- An individual name (e.g. "Zone1-fcu-500-xxx") may precede the device name/network name (e.g. fcu-500-xxx).
- The device name must at least consist of the expression: e.g. for FCU 500: "fcu-500-xxx", e.g. for BCU 570: "bcu-570-xxx".

- The address on the BCM set on the code switches must be identical to the address (xxx) entered in the automation system's network configuration.
- After the code switch settings have been changed, the control unit must be switched off and on again to enable the new address setting.

#### 1 Start the fieldbus communication.

- If the fault message n 0 to n 4 flashes in the control unit's display, fieldbus communication cannot be commissioned. The control unit can continue to be operated via its digital inputs (terminals 1 to 4, 44 and 50).

#### Parameter 80 = 2: Fieldbus communication without address check

- The device name/network name can be selected as required.

#### 1 Start the fieldbus communication.

- If the fault message n 0 to n 4 flashes in the control unit's display, fieldbus communication cannot be commissioned. The control unit can continue to be activated via the digital inputs.

## 6 ASSISTANCE IN THE EVENT OF MALFUNCTION

### DANGER

Electric shocks can be fatal!  
Before working on possible live components, ensure the unit is disconnected from the power supply.

Fault-clearance must only be undertaken by authorized trained personnel.

- Faults may be cleared only using the measures described below.
- If the control unit (FCU/BCU/FDU) does not respond even though all faults have been remedied: remove the unit and return it to the manufacturer for inspection.
- If a fault message (n 0, n 1, n 2, n 3 or n 4) is active, the control unit can continue to be operated via its digital inputs.

### ? Faults

- ! Cause
  - Remedy



### ? The display on the control unit blinks and indicates n 0.

- ! The control unit waits for connection with the automation system controller.
  - Check whether the controller is switched on.
  - Check the network wiring.
  - Check the controller's network configuration.
  - Check whether the device name/network name in the network configuration is the same as the BCM address setting.
  - Check whether the device name/network name in the network configuration is the same as the device name saved in the control unit.



### ? The display on the control unit blinks and indicates n 1.

- ! An invalid address has been set on the BCM.
- ! The address check has been activated on the control unit by setting parameter 80 = 1.
  - Check whether the BCM address is in the permitted address range (001 to FEF).
  - Check the value of parameter 80 and adjust it if necessary.

### PROFINET

- Adjust the code switch settings on the BCM to the device name assigned in the network configuration.

### Modbus TCP

- Adjust the code switch settings on the BCM to the network name.



### ? The display on the control unit blinks and indicates n 2.

- ! The BCM has received an incorrect configuration from the PROFINET controller.
  - Check whether the appropriate GSD file has been read into the automation system's engineering tool.
  - Check the device configuration.



- ? **The display on the control unit blinks and indicates n 3.**

### PROFINET

! The device name for the control unit (FCU/BCU/FDU) in the engineering tool is invalid or has not been entered.

! The address check has been activated on the control unit by setting parameter 80 = 1.

→

- Assign a network name corresponding to the default network name (bcu-560-xxx) or use the default name as a suffix of an individually assigned name in the following form: "individual-partofnamebcu-560-xxx".

→ Device name on delivery:  
e.g. for FCU 500 = **not-assigned-fcu-500-xxx**,  
e.g. for BCU 570 = **not-assigned-bcu-570-xxx**.

→ The device name must at least consist of the expression:  
e.g. for FCU 500 = **fcu-500-xxx**,  
e.g. for BCU 570 = **bcu-570-xxx**.  
Depending on the control unit (FCU/BCU/FDU) in use, the default value of the address will change. See page 5 (5.3 Parameter 80).

- Delete the expression "**not-assigned-**" in the engineering tool or replace it with an individual name (e.g. **Furnacezone1-**).
- Check whether the device name in the network configuration is the same as the device name saved in the control unit.
- Check the value of parameter 80 and adjust it if necessary.

### Modbus TCP

! The network name for the control unit (FCU/BCU/FDU) in BCSoft is invalid or has not been entered.

! The address check has been activated on the control unit by setting parameter 80 = 1.

→ The network name must at least consist of the expression:  
e.g. for FCU 500 = **fcu-500-xxx**,  
e.g. for BCU 570 = **bcu-570-xxx**  
(xxx = address in the range **001 to FEF**).

- Check in BCSoft whether the network name for the control unit (FCU/BCU/FDU) has been entered and is valid.
- Check the value of parameter 80 and adjust it if necessary.



- ? **The display on the control unit blinks and indicates n 4.**

! The PROFINET controller is set to Stop.

- Start the PROFINET controller.

**For other control unit fault messages, see BCU 56x, 580, BCU 570, FCU 500 or FDU 5x0 operating instructions, section entitled "Assistance in the event of malfunction".**

## 7 TECHNICAL DATA

### Ambient conditions

Icing, condensation and dew in and on the unit are not permitted.

Avoid direct sunlight or radiation from red-hot surfaces on the unit.

Note the maximum medium and ambient temperatures!

Avoid corrosive influences, e.g. salty ambient air or SO<sub>2</sub>. Ambient temperature:

-20 to +60°C (-4 to +140°F).

Transport temperature = ambient temperature.

Storage temperature:

-20 to +60°C (-4 to +140°F).

Enclosure: IP 20 pursuant to IEC 529.

Installation location: min. IP 54 (for installation in a control cabinet).

Permitted operating altitude: < 2000 m AMSL.

### Mechanical data

Dimensions (W × H × D):

32.5 × 110 × 100 mm (1.28 × 4.53 × 3.94 inches),

H = 115 mm (4.5 inches) incl. DIN rail.

Weight: 0.3 kg.

### Electrical data

Power consumption: 1.2 VA.

Power loss: 0.7 W.

### 7.1 Designed lifetime

Max. service life under operating conditions:

20 years after date of production.

## 8 LOGISTICS

### Transport

Protect the unit from external forces (blows, shocks, vibration).

Transport temperature: see page 8 (7 Technical data).

Transport is subject to the ambient conditions described.

Report any transport damage on the unit or packaging without delay.

Check that the delivery is complete.

### Storage

Storage temperature: see page 8 (7 Technical data).

Storage is subject to the ambient conditions described.

## FOR MORE INFORMATION

The Honeywell Thermal Solutions family of products includes Honeywell Combustion Safety, Eclipse, Exothermics, Hauck, Kromschroder and Maxon. To learn more about our products, visit [ThermalSolutions.honeywell.com](http://ThermalSolutions.honeywell.com) or contact your Honeywell Sales Engineer.

Elster GmbH  
Strotheweg 1, D-49504 Lotte  
T +49 541 1214-0  
[hts.lotte@honeywell.com](mailto:hts.lotte@honeywell.com)  
[www.kromschroeder.com](http://www.kromschroeder.com)

Global centralized service deployment coordination:  
T +49 541 1214-365 or -555  
[hts.service.germany@honeywell.com](mailto:hts.service.germany@honeywell.com)

Storage time: 6 months in the original packaging before using for the first time. If stored for longer than this, the overall service life will be reduced by the corresponding amount of extra storage time.

## 9 DISPOSAL

Devices with electronic components:

**WEEE Directive 2012/19/EU – Waste Electrical and Electronic Equipment Directive**



At the end of the product life (number of operating cycles reached), dispose of the packaging and product in a corresponding recycling centre. Do not dispose of the unit with the usual domestic refuse. Do not burn the product. On request, old units may be returned carriage paid to the manufacturer in accordance with the relevant waste legislation requirements.

**Honeywell**  
**kromschroder**

Translation from the German  
© 2022 Elster GmbH